



TECHNICAL DATASHEET

TOPLA TOP JIS TT60J

ORDER INFORMATION

TAB ID
118861

Short Code
TT60J

DIN Marking
56068 SMF

EAN Code
3838807030480

Quantity per EU/CNT pallet
60/90 pcs

TECHNOLOGY

Primary Function
Engine Start

Battery Technology
Flooded

Grid Type (pos/neg)
Expanded/Concasted

Grid Alloy (pos/neg)
Ca/Ca

Separator
PE

Electrolyte (g/cm³)
1,28

TECHNICAL INFORMATION

Voltage (V)
12

Capacity C20 (Ah)
60

CCA -18°C EN (A)
600

RC (min)
100

LxWxH (mm)
230x173x200/220

Total Weight (kg)
14.9

BOX DESIGN

Box Type
D23

Cover Type
SMF

Colour
Black

Layout
0

BHD
B01

Terminal
1

DRAWING

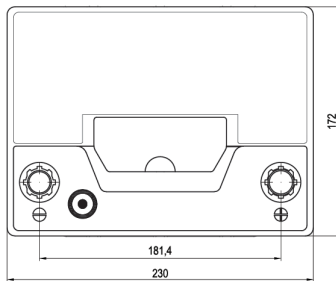
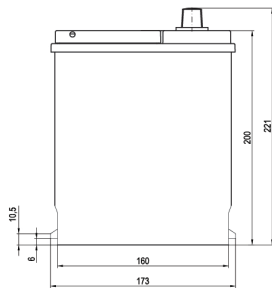
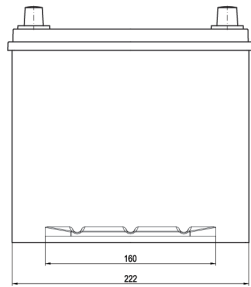

BHD



LAYOUT

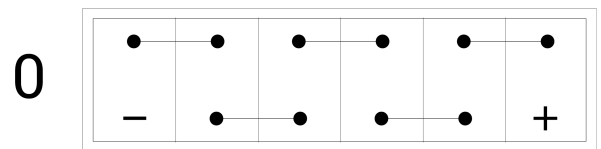

TERMINAL

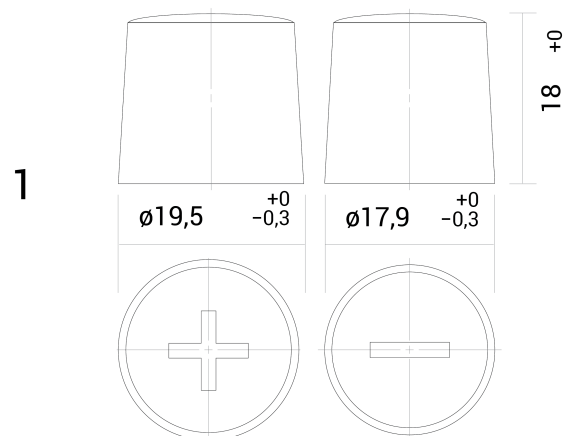

TECHNICAL DATASHEET

TOPLA TOP JIS TT60J