



TECHNICAL DATASHEET

TOPLA TOP TT66H

ORDER INFORMATION

TAB ID
118666

Short Code
TT66H

DIN Marking
56649 SMF

EAN Code
3838807027572

Quantity per EU/CNT pallet
63/90 pcs

TECHNOLOGY

Primary Function
Engine Start

Battery Technology
Flooded

Grid Type (pos/neg)
Expanded/Concasted

Grid Alloy (pos/neg)
Ca/Ca

Separator
PE

Electrolyte (g/cm³)
1,28

TECHNICAL INFORMATION

Voltage (V)
12

Capacity C20 (Ah)
66

CCA -18°C EN (A)
640

RC (min)
111

LxWxH (mm)
242x175x190

Total Weight (kg)
15.0

BOX DESIGN

Box Type
L2

Cover Type
SMF

Colour
Black

Layout
0

BHD
B13

Terminal
1

DRAWING

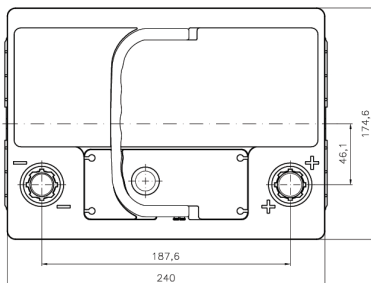
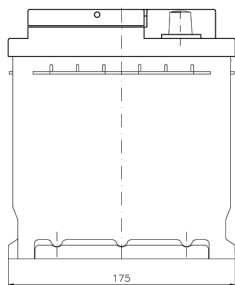
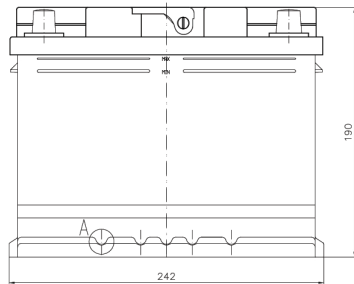

BHD



LAYOUT

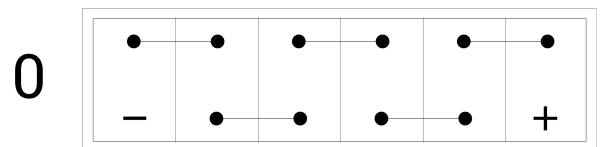

TERMINAL

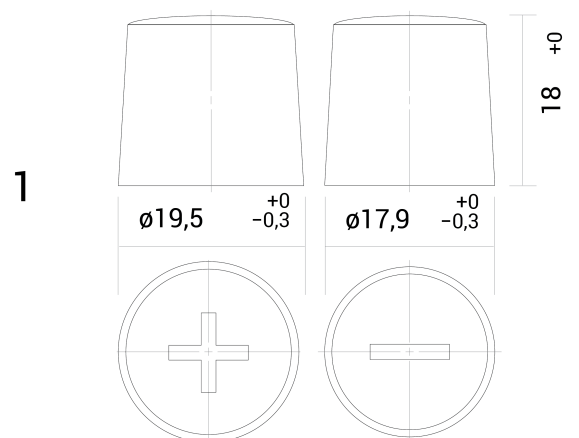

TECHNICAL DATASHEET

TOPLA TOP TT66H