

TECHNICAL DATASHEET

TOPLA TOP TT75

ORDER INFORMATION

TAB ID
118072

Short Code
TT75

DIN Marking
57510 SMF

EAN Code
3838807020429

Quantity per EU/CNT pallet
51/80 pcs

TECHNOLOGY

Primary Function
Engine Start

Battery Technology
Flooded

Grid Type (pos/neg)
Expanded/Concasted

Grid Alloy (pos/neg)
Ca/Ca

Separator
PE

Electrolyte (g/cm³)
1,28

TECHNICAL INFORMATION

Voltage (V)
12

Capacity C20 (Ah)
75

CCA -18°C EN (A)
720

RC (min)
129

LxWxH (mm)
278x175x175

Total Weight (kg)
16.5

BOX DESIGN

Box Type
L3B

Cover Type
SMF

Colour
Black

Layout
0

BHD
B13

Terminal
1

DRAWING

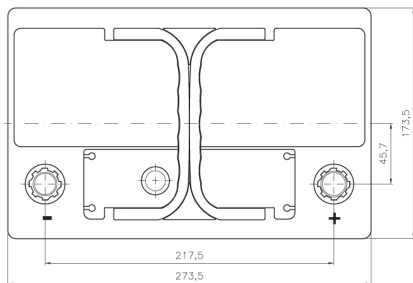
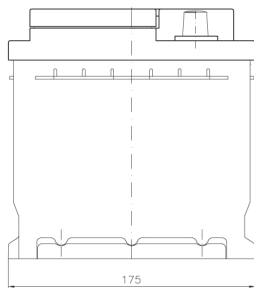
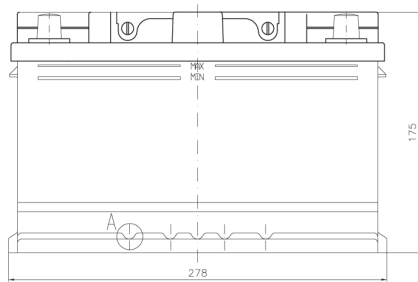

BHD

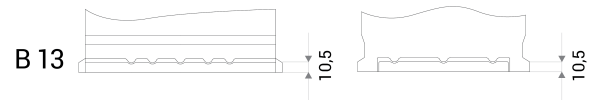

LAYOUT

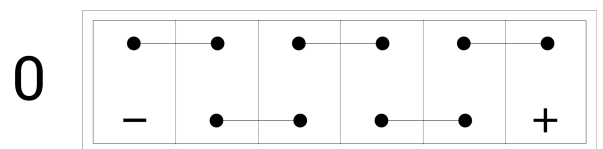

TERMINAL

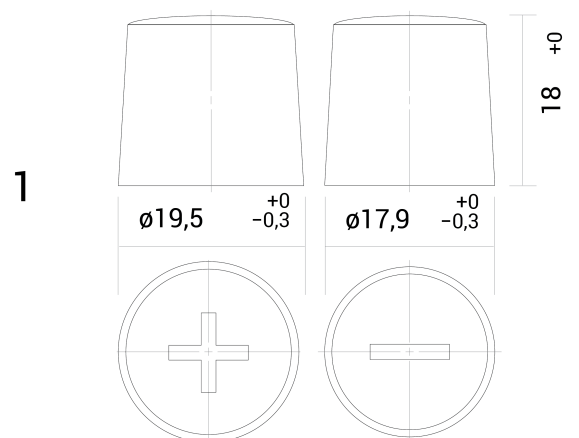

TECHNICAL DATASHEET

TOPLA TOP TT75